

REV	DESCRIPTION	DATE	APPROVED
S0	CREATED DRAWING	2019/02/19	CYF

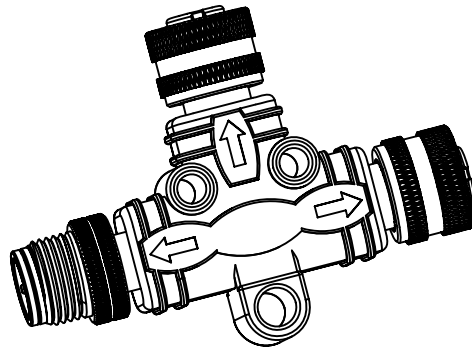

P2

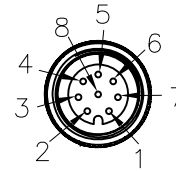

P3

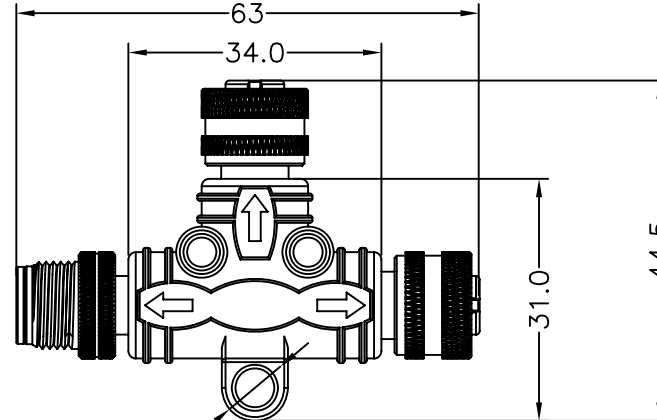
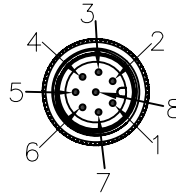

P1

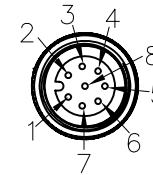

Detailed Product Description:  
Waterproof connector rating is IP67  
They can not be used permanently under water

Connector Electrical character  
Rating voltage: 30V  
Insulation resistance: >100MΩ  
Rating current: 2A  
Contact resistance of connector ≤10mΩ  
Mechanical characteristics: mating / cycle >100cycle  
Operating temperature: -25°C ~ +85°

TESTING CONDITIONS:  
1. VOLTAGE: 300V DC/0.1S  
2. 100% OPEN AND SHORT ELECTRICAL TEST

\*ALL MATERIALS ARE RoHS COMPLIANT\*

WIRE LIST

P1	COLOR	P2	P3
1	WHITE	1	1
2	BROWN	2	2
3	GREEN	3	3
4	YELLOW	4	4
5	GREY	5	5
6	PINK	6	6
7	BLUE	7	7
8	RED	8	8

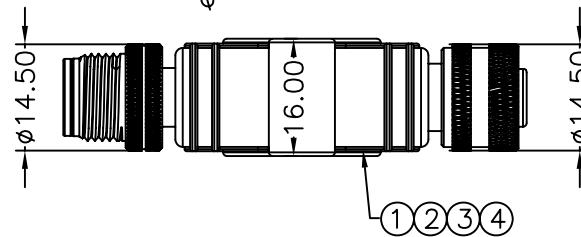

ITEM	PART NO.	SPECIFICATION	Q'TY	UNIT
⑤	PL00007	HD PE	8	g
④	PL00008	BLACK PVC 30P	35	g
③	N/A	M12 A CODING 8PIN FEMALE CONNECTOR	2	SET
②	N/A	M12 A CODING 8PIN MALE CONNECTOR	1	SET
①	N/A	24AWG HOOK UP WIRE	1	PCS



**SIGNAL**<sup>®</sup>

Shenzhen Signal Electronics Co., LTD

TITLE  
M12 8P/M TO 8P/F\*2 ADAPTER

SGN NO 120108-10-007

DWG NO

CUSTOMER

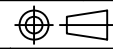
DRAWN BY	DATE	TOLERANCES ARE: DECIMALES ANGLES .x ±0.5 x.' ±2.0' .xx ±0.20 .x' ±1.0'	THIRD ANGLE PROJECTION 
CHECKED BY	DATE		
APPROVED BY	DATE		

THE INFORMATION CONTAINED IN THIS DRAWING IS THE SOLE PROPERTY OF SIGNAL COMPANY. ANY REPRODUCTION IN PART OR WHOLE WITHOUT THE WRITTEN PERMISSION OF SIGNAL COMPANY IS PROHIBITED.

SIZE: A4	UNITS: mm
SCALE:	SHEET: 1 OF 1