

REV	DESCRIPTION	DATE	APPROVED
S0	CREATED DRAWING	2020/04/22	ZK
S1	ADD CONFORMITY CRITERIA	2024/04/19	CBT

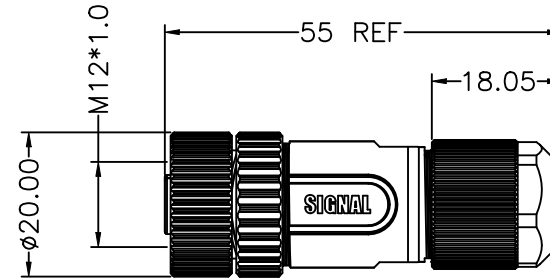

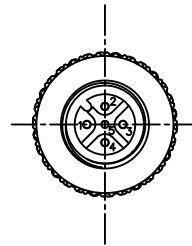



Detailed Product Description:  
 Waterproof connector rating is IP67  
 They can not be used permanently under water  
 Per ISO-20653,IEC60529

Mechanical characteristics: mating / cycle >100cycle  
 Operating temperature: -25°C ~ +85°C  
 Meets IEC 61076-2-101 

\*ALL MATERIALS ARE RoHS COMPLIANT\*



Electrical character

Part Number	Contacts	Rated voltage		Rated current	Contact Resistance	Cable OD (mm)
		A/C	D/C			
120103-02-007S		250V	250V	4A	10mΩ	4~8
120104-02-007S		250V	250V	4A	10mΩ	4~8
120404-02-007S		250V	250V	4A	10mΩ	4~8
120205-02-003S		60V	60V	4A	10mΩ	4~8
120105-02-007S ✓		60V	60V	4A	10mΩ	4~8
120108-02-007S		30V	30V	2A	10mΩ	4~8

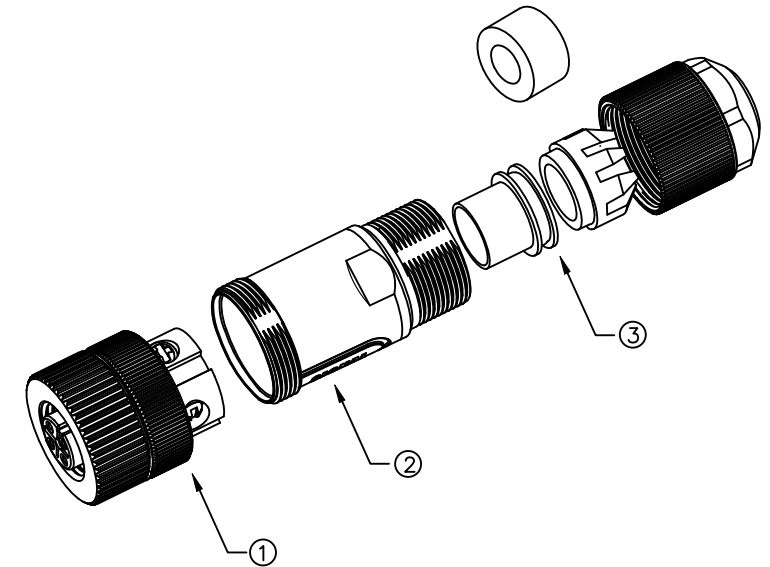

③	N/A	M12 TAIL WATERPROOF PARTS	1	SET
②	N/A	M12 ASSEMBLY SHELL	1	SET
①	N/A	M12 FEMALE CONNECTOR	1	SET
ITEM	PART NO.	SPECIFICATION	Q'TY	UNIT

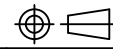
 <b>SIGNAL</b> <sup>®</sup> Shenzhen Signal Electronics co.,Ltd		TITLE	
DRAWN BY		M12 FEMALE ASSEMBLY CONNECTOR	
CHECKED BY		SGN NO	120103~08-02-007S
CHECKED BY		DWG NO	
APPROVED BY		CUSTOMER	
DATE		REV.	S1
DATE		TOLERANCES ARE:	
DATE		DECIMALES	ANGLES
DATE		.x ±0.50	x.' ±2.0'
DATE		.xx ±0.20	.x' ±1.0'
DATE		THIRD ANGLE PROJECTION	
DATE		SIZE: A4	UNITS: mm
DATE		SCALE: 1:1	SHEET: 1 OF 1