

REV	DESCRIPTION	DATE	APPROVED
S0	CREATED DRAWING	2021/11/08	ZZJ
S1	CREATED DRAWING	2022/06/09	CYF

Detailed Product Description:
Waterproof connector rating is IP67
Per ISO-20653, IEC60529

Connector Electrical character
Rating voltage: SEE LIST
Insulation resistance: >100MΩ
Rating current: SEE LIST
Contact resistance of connector <10mΩ
Mechanical characteristics: mating/cycle >100 cycle
Operating temperature: -25°C ~ +85°C

Other Specification
Contact PIN: Brass copper with Gold plating
Coupling nut/screw: Brass nickel plated
Contact body material: TPU
Insulation plastic: PA66+GF UL94 V-0

Conductor installation method: lock screw
Torque : 0.8 Nm (7/8" plug-in connector) / 0.4 Nm (screw terminal)
Cross-sectional area: MAX 1.5mm²
1 Nm ... 1.4 Nm (fastening nut)

*ALL MATERIALS ARE RoHS COMPLIANT

Electrical character

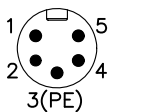
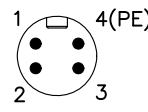
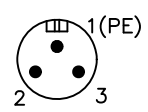
Part Number	Contacts	Rated voltage		Rated current	Cable OD (mm)
		A/C	D/C		
780005-01-004	 3(PE)	300V	300V	9A	6.0~12.0
780004-01-005	 4(PE)	300V	300V	9A	6.0~12.0
780003-01-004	 1(PE)	300V	300V	12A	6.0~12.0

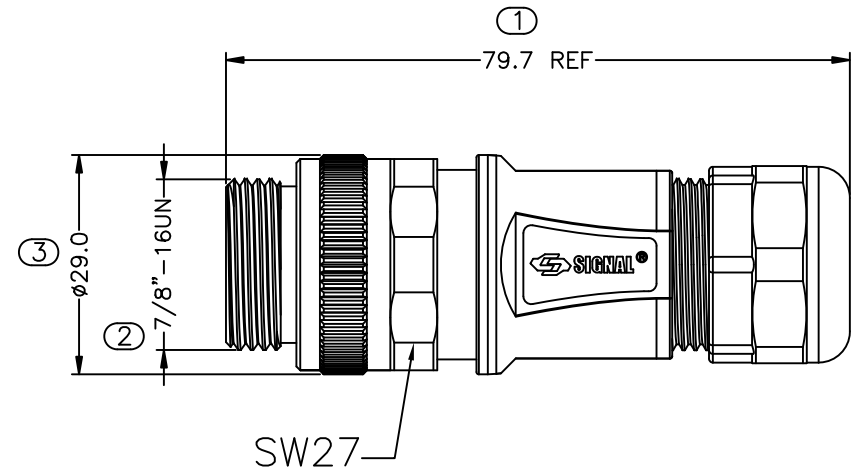
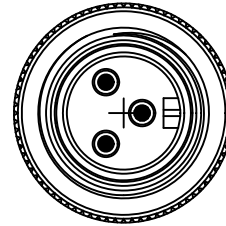

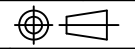
 SIGNAL [®] Shenzhen Signal Electronics co.,Ltd		TITLE 7/8" *P/M ASSEMBLY CONNECTOR	
		SGN NO SEE LIST	REV. S1
DRAWN BY	DATE	DWG NO	
CHECKED BY	DATE	CUSTOMER	
CHECKED BY	DATE	APPROVED BY	
APPROVED BY	DATE	TOLERANCES ARE:	
<small>THE INFORMATION CONTAINED IN THIS DRAWING IS THE SOLE PROPERTY OF SIGNAL COMPANY. ANY REPRODUCTION IN PART OR WHOLE WITHOUT THE WRITTEN PERMISSION OF SIGNAL COMPANY IS PROHIBITED.</small>		DECIMALES .x ±0.5 .xx ±0.2	ANGLES x.' ±1.0' .x' ±0.5'
		THIRD ANGLE PROJECTION 	SCALE: A4 UNITS: mm SHEET: 1 OF 1