

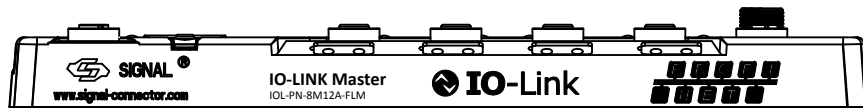

REV	DESCRIPTION	DATE	APPROVED
S0	CREATED DRAWING	2024/01/04	ZK

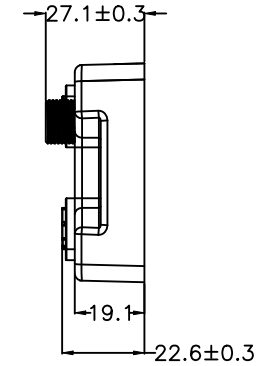

METAL PN

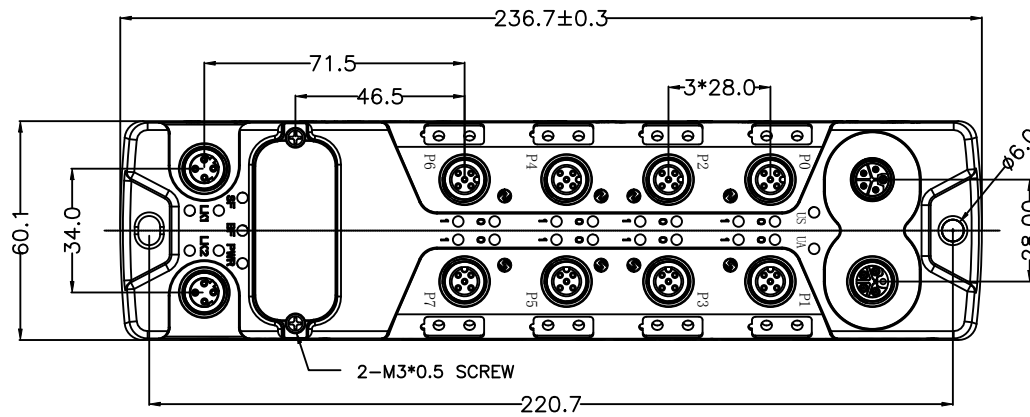
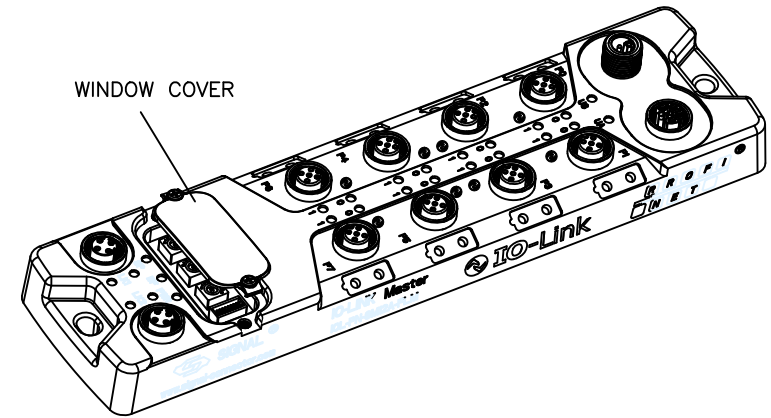

13	GL00002	BLACK EPOXY GLUE	40	G
12	GL00029	TRANSPARENT EPOXY GLUE	15	G
11	GL00026	GLUE B	8	G
10	SW00038	SCREW M3*0.5	7	PCS
9	OR00284	WATERPROOF APRONS	1	PCS
8	PC00170-1	PCB BOARD WITH COMPONENTS	1	SET
7	121005-04-021	M12 L CODE 5P(4+FE) FEMALE PANEL CONNECTOR	1	SET
6	121005-03-024	M12 L CODE 5P(4+FE) MALE PANEL CONNECTOR	1	SET
5	120404-04-164	M12 D CODE 4P FEMALE PANEL CONNECTOR	2	SET
4	120105-04-168	M12 A CODE 5P FEMALE PANEL CONNECTOR	8	SET
3	YDLE0017	LIGHT GUIDE PILLAR	25	PCS
2	CN01313	TRANSPARENT WINDOW COVER	1	PCS
1	YDWK0889-1	IO-LINK JUNCTION BOX SHELL , METAL, BLACK, (WITH SIGNAL LOGO)	1	PCS
ITEM	PART NO.	SPECIFICATION	Q'TY	UNIT

 Shen Zhen Signal Electronics co.,Ltd		TITLE IO-LINK JUNCTION BOX (M12 5P A/F*4+ M12 5P B/F*4+M12 4P D/F*2+M12 L 5P/M+ M12 L 5P/F)(METAL UNIBODY)	
		SGN NO 920105-08-037	REV.
DRAWN BY	DATE	DWG NO SGN YD2312081	S0
CHECKED BY	DATE	CUSTOMER	
APPROVED BY	DATE	TOLERANCES ARE: DECIMALES ANGLES .x ±0.2 .x' ±2.0' .xx ±0.10 .x'' ±1.0'	
THE INFORMATION CONTAINED IN THIS DRAWING IS THE SOLE PROPERTY OF SIGNAL COMPANY. ANY REPRODUCTION IN PART OR WHOLE WITHOUT THE WRITTEN PERMISSION OF SIGNAL COMPANY IS PROHIBITED.		THIRD ANGLE PROJECTION	SIZE: A4 UNITS: mm
		SCALE: 1:1	SHEET: 1 OF 2

REV	DESCRIPTION	DATE	APPROVED
S0	CREATED DRAWING	2024/01/04	ZK

Electrical data
 Operating voltage: V1 24 VDC /V2 48 VDC
 Operating Current: V1 24 VDC,80mA/V2 48 VDC,20mA
 Current sum max: 9A
 UA/US isolated: yes
 Output current max(per port): 4A

Inputs/Outputs
 Configurable inputs/outputs: Yes
 Digital inputs: 16x PNP, Type 3
 Digital outputs: 8x PNP
 Power Supply, Sensor: Us
 Power Supply, Actuator: Us
 short-circuit proof (Input): yes
 short-circuit proof (Output): yes

Electrical connection
 Connection 1: M12x1-Female, 4-pin, D-coded
 Connection 2: M12x1-Female, 4-pin, D-coded
 Connection (supply voltage IN): M12 L-Male, 5-pin
 Connection (supply voltage OUT): M12 L-Female, 5-pin
 IO-Link interface: 8x M12x1-Female, 5-pin, A-coded

Environmental conditions
 Ambient temperature: -25...55°C
 Storage temperature: -40...70°C
 IP rating: IP67, when threaded in

IO-Link Master
 Port-class: Class A
 Transmission type: PNP
 Number of ports class A: 8

Mechanical data
 Dimension: 60.1 x 22.6 x 236.7 mm
 Mounting ground: M5 screws
 Mounting part: 2-hole screw mount
 Housing Material: Aluminum alloy

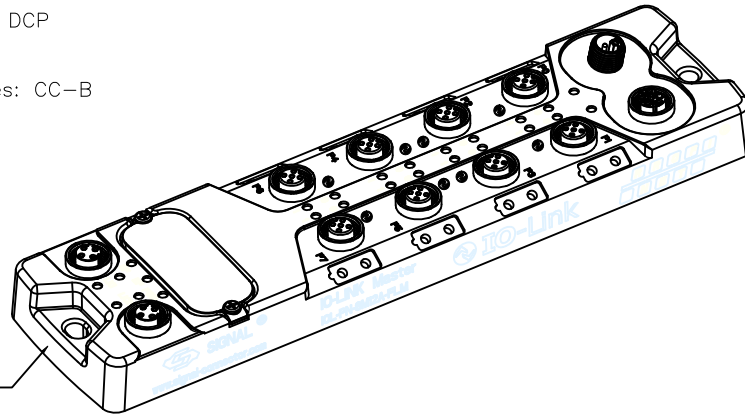
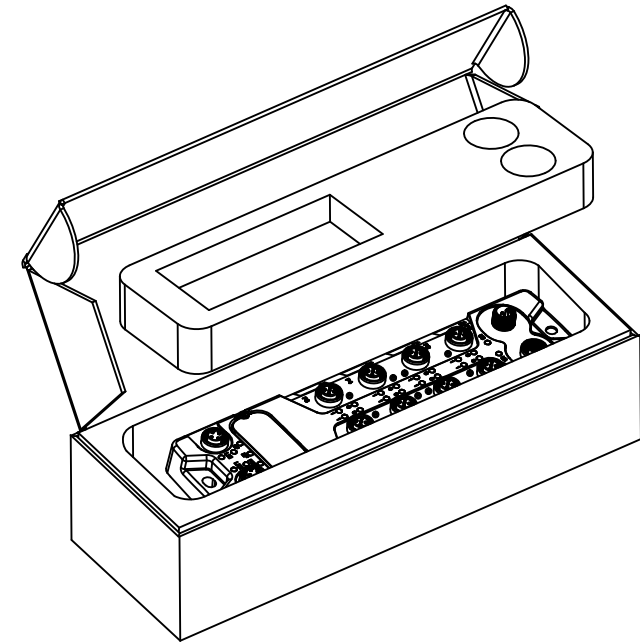

Ethernet-PROFINET
 Protocol: PROFINET
 Transmission rate: 10/100Mbit/s
 Address range: IPv4
 Addressing Devices: DCP
 Topology: yes
 SNMP: yes
 Conformance Classes: CC-B

PACKING METHOD



Laser engraving
 SN-O11LM010001

Product code (change according to actual production)

 Shen Zhen Signal Electronics co.,Ltd		TITLE IO-LINK JUNCTION BOX (M12 5P A/F*4+ M12 5P B/F*4+M12 4P D/F*2+M12 L 5P/M+ M12 L 5P/F)(METAL UNIBODY)	
		SGN NO	920105-08-037
DRAWN BY		DATE	
CHECKED BY		DATE	
APPROVED BY		DATE	
THE INFORMATION CONTAINED IN THIS DRAWING IS THE SOLE PROPERTY OF SIGNAL COMPANY. ANY REPRODUCTION IN PART OR WHOLE WITHOUT THE WRITTEN PERMISSION OF SIGNAL COMPANY IS PROHIBITED.		TOLERANCES ARE:	
		DECIMALES	ANGLES
		.x ±0.2.	x' ±2.0'
		xx ±0.10	x' ±1.0'
		THIRD ANGLE PROJECTION 	
		SIZE: A4	UNITS: mm
		SCALE: 1:1	SHEET: 2 OF 2

ITEM	PART NO.	SPECIFICATION	Q'TY	UNIT
16	ZX00172	PACKING FOAM A (236mm*62mm*25mm)	1	PCS
15	ZX00171	PACKING FOAM A (260mm*84mm*58mm)	1	PCS
14	ZX00170	PACKING CARTONS (260mm*84mm*58mm)	1	PCS