

# USB Connectors



## USB Connectors

1.USB Panel Mount

U001-U005

2.USB Molded Cable

U006-U012

3.USB Protection Cap

U013-U013

3.USB Nut and Oring

U013-U013

# USB Connectors

## USB 2.0 A Type Female Panel Mount, Solder

Product figure (front fastened)



Scale diagram

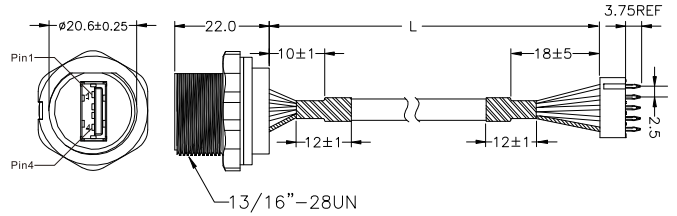

Contact layout/针孔排布 (Front view/前视图)

4pins

A

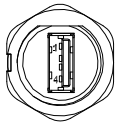

### Order Data/订货信息

Contacts/芯数	Cable length/线材长度	Order No/订货号
4pins	50MM	940104-04-001
	150MM	940104-04-005
	200MM	940104-04-006

### Specifications/技术参数

Number of contacts/芯数	4
Connector Style/连接器样式	USB 2.0 A/F
Termination/接线方式	Solder
Protection degree/防护等级	IP67
Operating temperature/工作温度	-25°C ~ +80°C
Rated voltage/额定电压	30V
Rated current (40°C)/额定电流	1.5A
Contact resistance/接触阻抗	≤30mΩ
Insulation resistance/绝缘阻抗	≥100MΩ
Connector insert/胶芯材料	PBT + GF
Connector contacts/端子材料	Brass with gold plated/黄铜镀金
Cable jacket/线材外被	PUR/PVC
Wire insulation/芯线绝缘	PVC
Shielding/是否屏蔽	Shielded/是
Cable end/线材尾部	PH2.5MM 5PIN

# USB Connectors

## USB 2.0 B Type, Female Panel Mount, Solder

Product figure (front fastened)



Scale diagram

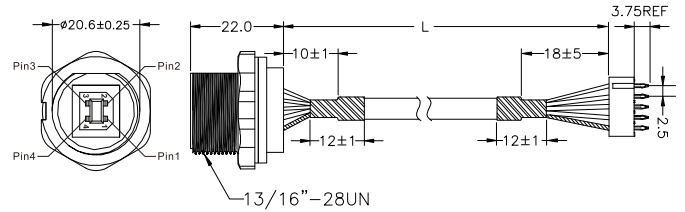

Contact layout/针孔排布 (Front view/前视图)

4pins

B



### Order Data/订货信息

Contacts/芯数	Cable length/线材长度	Order No/订货号
4pins	50MM	940204-04-001
	150MM	940204-04-005
	200MM	940204-04-006

### Specifications/技术参数

Number of contacts/芯数	4
Connector Style/连接器样式	USB 2.0 B/F
Termination/接线方式	Solder
Protection degree/防护等级	IP67
Operating temperature/工作温度	-25°C~+80°C
Rated voltage/额定电压	30V
Rated current (40°C)/额定电流	1.5A
Contact resistance/接触阻抗	≤30mΩ
Insulation resistance/绝缘阻抗	≥100MΩ
Connector insert/胶芯材料	PBT+GF
Connector contacts/端子材料	Brass with gold plated/黄铜镀金
Cable jacket/线材外被	PUR/PVC
Wire insulation/芯线绝缘	PVC
Shielding/是否屏蔽	Shielded/是
Cable end/线材尾部	PH2.5MM 5PIN

# USB Connectors

## USB 2.0 A Type Female Panel Mount, Solder

Product figure (front fastened)



Scale diagram

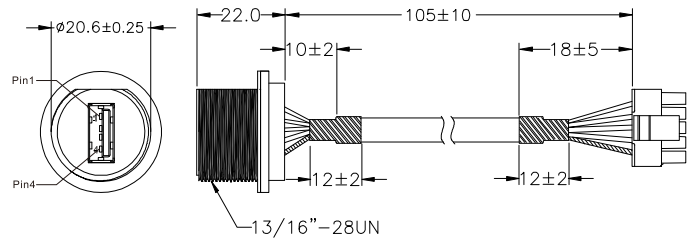

Contact layout/针孔排布 (Front view/前视图)

4pins

A

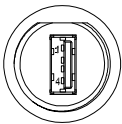

### Order Data/订货信息

Contacts/芯数	Order No/订货号
4pins	940104-04-002

### Specifications/技术参数

Number of contacts/芯数	4
Connector Style/连接器样式	USB 2.0 A/F
Termination/接线方式	Solder
Protection degree/防护等级	IP67
Operating temperature/工作温度	-25°C ~ +80°C
Rated voltage/额定电压	30V
Rated current (40°C)/额定电流	1.5A
Contact resistance/接触阻抗	≤30mΩ
Insulation resistance/绝缘阻抗	≥100MΩ
Connector insert/胶芯材料	PBT+GF
Connector contacts/端子材料	Brass with gold plated/黄铜镀金
Cable jacket/线材外被	PUR/PVC
Wire insulation/芯线绝缘	PVC
Shielding/是否屏蔽	Shielded/是
Cable end/线材尾部	Molex 43645-0500

# USB Connectors

## USB 2.0 A Type Female Panel Mount, Solder

Product figure (front fastened)



Scale diagram

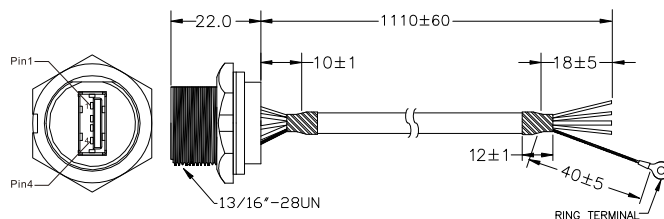

Contact layout/针孔排布 (Front view/前视图)

4pins

A

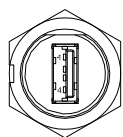

### Order Data/订货信息

Contacts/芯数	Order No/订货号
4pins	940104-04-003

### Specifications/技术参数

Number of contacts/芯数	4
Connector Style/连接器样式	USB 2.0 A/F
Termination/接线方式	Solder
Protection degree/防护等级	IP67
Operating temperature/工作温度	-25°C ~ +80°C
Rated voltage/额定电压	30V
Rated current (40°C)/额定电流	1.5A
Contact resistance/接触阻抗	≤30mΩ
Insulation resistance/绝缘阻抗	≥100MΩ
Connector insert/胶芯材料	PBT+GF
Connector contacts/端子材料	Brass with gold plated/黄铜镀金
Cable jacket/线材外被	PUR/PVC
Wire insulation/芯线绝缘	PVC
Shielding/是否屏蔽	Shielded/是
Cable end/线材尾部	ø3.5 Ring Terminal

# USB Connectors

## USB 3.0 A Type Female Panel Mount, Solder

Product figure (front fastened)



Scale diagram

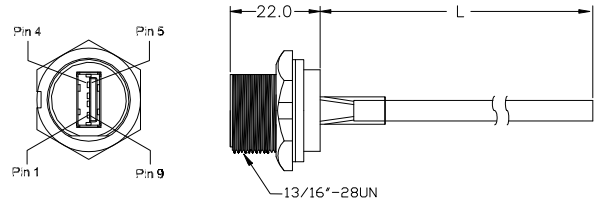

Contact layout/针孔排布 (Front view/前视图)

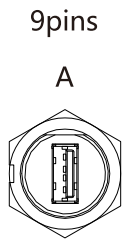

### Order Data/订货信息

Contacts/芯数	Cable length/线材长度	Order No/订货号
9pins	100MM	940104-04-007
	150MM	940104-04-008
	250MM	940104-04-004

### Specifications/技术参数

Number of contacts/芯数	9
Connector Style/连接器样式	USB 3.0 A/F
Termination/接线方式	Solder
Protection degree/防护等级	IP67
Operating temperature/工作温度	-25°C ~ +80°C
Rated voltage/额定电压	30V
Rated current (40°C)/额定电流	1.5A
Contact resistance/接触阻抗	≤30mΩ
Insulation resistance/绝缘阻抗	≥100MΩ
Connector insert/胶芯材料	PBT+GF
Connector contacts/端子材料	Brass with gold plated/黄铜镀金
Cable jacket/线材外被	PUR/PVC
Wire insulation/芯线绝缘	PVC
Shielding/是否屏蔽	Shielded/是

## USB 2.0 A Type Male Molded Cable

Product figure



Scale diagram

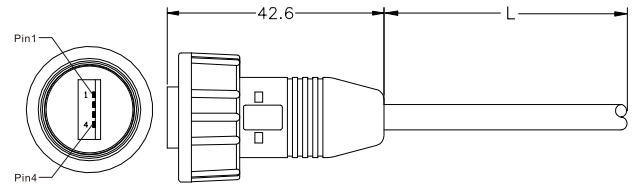

Contact layout/针孔排布 (Front view/前视图)

4pins

A

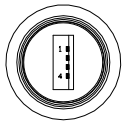

### Order Data/订货信息

Contacts/芯数	Cable length/线材长度	Order No/订货号
4pins	1.0M	940104-05-002
	3.0M	940104-05-003

### Specifications/技术参数

Number of contacts/芯数	4
Connector Style/连接器样式	USB 2.0 A/M
Termination/接线方式	Solder
Protection degree/防护等级	IP67
Operating temperature/工作温度	-25°C ~ +80°C
Rated voltage/额定电压	30V
Rated current (40°C)/额定电流	1.5A
Contact resistance/接触阻抗	≤30mΩ
Insulation resistance/绝缘阻抗	≥100MΩ
Connector insert/胶芯材料	PBT + GF
Connector contacts/端子材料	Brass with gold plated/黄铜镀金
Cable jacket/线材外被	PUR/PVC
Wire insulation/芯线绝缘	PVC
Shielding/是否屏蔽	Shielded/是



# USB Connectors

## USB 2.0 B Type Male Molded Cable

Product figure



Scale diagram

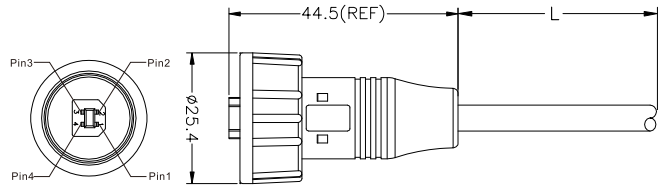

Contact layout/针孔排布 (Front view/前视图)

4pins

B



### Order Data/订货信息

Contacts/芯数	Cable length/线材长度	Order No/订货号
4pins	1.0M	940204-05-001
	3.0M	940204-05-002

### Specifications/技术参数

Number of contacts/芯数	4
Connector Style/连接器样式	USB 2.0 B/M
Termination/接线方式	Solder
Protection degree/防护等级	IP67
Operating temperature/工作温度	-25°C ~ +80°C
Rated voltage/额定电压	30V
Rated current (40°C)/额定电流	1.5A
Contact resistance/接触阻抗	≤30mΩ
Insulation resistance/绝缘阻抗	≥100MΩ
Connector insert/胶芯材料	PBT+GF
Connector contacts/端子材料	Brass with gold plated/黄铜镀金
Cable jacket/线材外被	PUR/PVC
Wire insulation/芯线绝缘	PVC
Shielding/是否屏蔽	Shielded/是



## USB 2.0 A Type Female Molded Cable

Product figure



Scale diagram

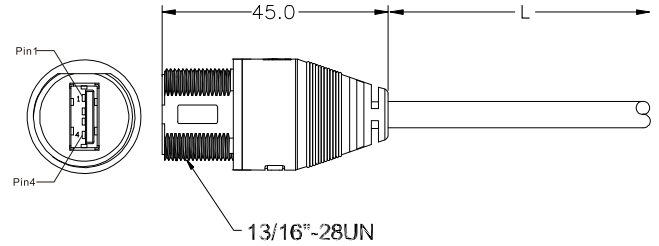

Contact layout/针孔排布 (Front view/前视图)

4pins

A

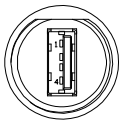

### Order Data/订货信息

Contacts/芯数	Cable length/线材长度	Order No/订货号
4pins	1.0M	940104-06-001
	3.0M	940104-06-003

### Specifications/技术参数

Number of contacts/芯数	4
Connector Style/连接器样式	USB 2.0 A/F
Termination/接线方式	Solder
Protection degree/防护等级	IP67
Operating temperature/工作温度	-25°C ~ +80°C
Rated voltage/额定电压	30V
Rated current (40°C)/额定电流	1.5A
Contact resistance/接触阻抗	≤30mΩ
Insulation resistance/绝缘阻抗	≥100MΩ
Connector insert/胶芯材料	PBT + GF
Connector contacts/端子材料	Brass with gold plated/黄铜镀金
Cable jacket/线材外被	PUR/PVC
Wire insulation/芯线绝缘	PVC
Shielding/是否屏蔽	Shielded/是

# USB Connectors

## USB 2.0 B Type Female Molded Cable

Product figure



Scale diagram

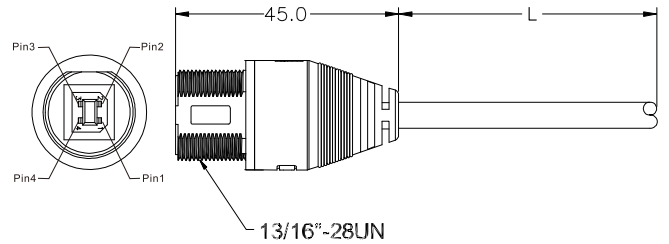

Contact layout/针孔排布 (Front view/前视图)

4pins

B



### Order Data/订货信息

Contacts/芯数	Cable length/线材长度	Order No/订货号
4pins	1.0M	940204-06-001
	3.0M	940204-06-003

### Specifications/技术参数

Number of contacts/芯数	4
Connector Style/连接器样式	USB 2.0 B/F
Termination/接线方式	Solder
Protection degree/防护等级	IP67
Operating temperature/工作温度	-25°C ~ +80°C
Rated voltage/额定电压	30V
Rated current (40°C)/额定电流	1.5A
Contact resistance/接触阻抗	≤30mΩ
Insulation resistance/绝缘阻抗	≥100MΩ
Connector insert/胶芯材料	PBT + GF
Connector contacts/端子材料	Brass with gold plated/黄铜镀金
Cable jacket/线材外被	PUR/PVC
Wire insulation/芯线绝缘	PVC
Shielding/是否屏蔽	Shielded/是

# USB Connectors

## USB 2.0 A Type Female to Male Molded Cable

Product figure (with cap)



Scale diagram

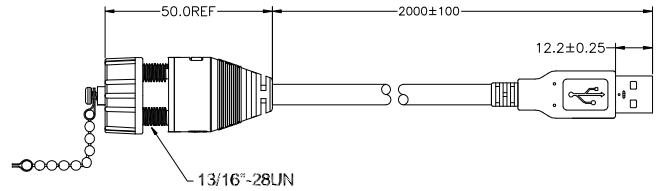

Contact layout/针孔排布 (Front view/前视图)

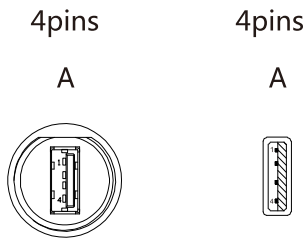

### Order Data/订货信息

Contacts/芯数	Cable length/线材长度	Order No/订货号
4pins	2.0M	940104-66-001

### Specifications/技术参数

Number of contacts/芯数	4
Connector Style/连接器样式	USB 2.0 A/F-M
Termination/接线方式	Solder
Protection degree/防护等级	IP67
Operating temperature/工作温度	-25°C ~ +80°C
Rated voltage/额定电压	30V
Rated current (40°C)/额定电流	1.5A
Contact resistance/接触阻抗	≤30mΩ
Insulation resistance/绝缘阻抗	≥100MΩ
Connector insert/胶芯材料	PBT+GF
Connector contacts/端子材料	Brass with gold plated/黄铜镀金
Cable jacket/线材外被	PUR/PVC
Wire insulation/芯线绝缘	PVC
Shielding/是否屏蔽	Shielded/是

## USB Connectors

### USB 2.0 A Type Female to M12 B-coded Male Molded Cable

Product figure



Scale diagram

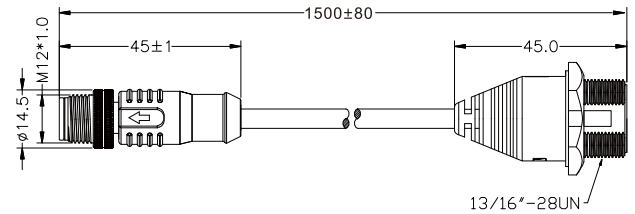

Contact layout/针孔排布 (Front view/前视图)

4pins

A

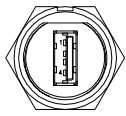

5pins

B

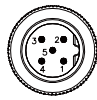

### Order Data/订货信息

Contacts/芯数	Cable length/线材长度	Order No/订货号
4-5pins	1.5M	120205-05-007

### Specifications/技术参数

Number of contacts/芯数	4-5
Connector Style/连接器样式	USB 2.0 A/F to M12 B/M
Termination/接线方式	Solder
Protection degree/防护等级	IP67
Operating temperature/工作温度	-25°C ~ +80°C
Rated voltage/额定电压	30V
Rated current (40°C)/额定电流	1.5A
Contact resistance/接触阻抗	≤30mΩ
Insulation resistance/绝缘阻抗	≥100MΩ
Connector insert/胶芯材料	PBT+GF
Connector contacts/端子材料	Brass with gold plated/黄铜镀金
Cable jacket/线材外被	PUR/PVC
Wire insulation/芯线绝缘	PVC
Shielding/是否屏蔽	Unshielded/否

# USB Connectors

## USB 2.0 A Type Female to M12 B-coded Male Molded Cable (with shield)

Product figure



Scale diagram

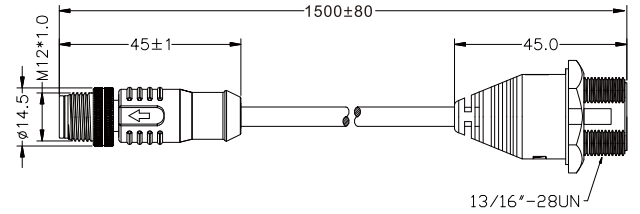

Contact layout/针孔排布 (Front view/前视图)

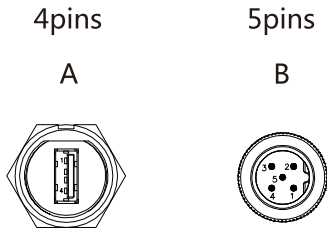

### Order Data/订货信息

Contacts/芯数	Cable length/线材长度	Order No/订货号
4-5pins	1.5M	120205-05-008

### Specifications/技术参数

Number of contacts/芯数	4-5
Connector Style/连接器样式	USB 2.0 A/F to M12 B/M
Termination/接线方式	Solder
Protection degree/防护等级	IP67
Operating temperature/工作温度	-25°C ~ +80°C
Rated voltage/额定电压	30V
Rated current (40°C)/额定电流	1.5A
Contact resistance/接触阻抗	≤30mΩ
Insulation resistance/绝缘阻抗	≥100MΩ
Connector insert/胶芯材料	PBT+GF
Connector contacts/端子材料	Brass with gold plated/黄铜镀金
Cable jacket/线材外被	PUR/PVC
Wire insulation/芯线绝缘	PVC
Shielding/是否屏蔽	Shielded/是

# USB Connectors

## USB Protection Cap for Female Connector

Product figure



Scale diagram

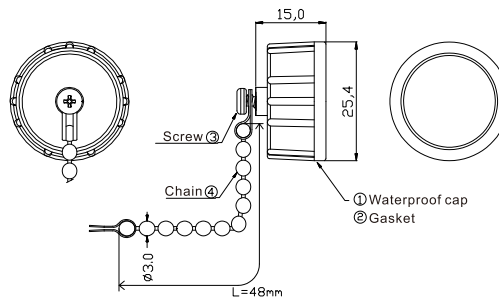

### Order Data/订货信息

Order No/订货号
940000-00-056

### Specifications/技术参数

Materials/材料	PBT + GF
Protection degree/防护等级	IP67

## USB Nut and Oring

Product figure



Scale diagram

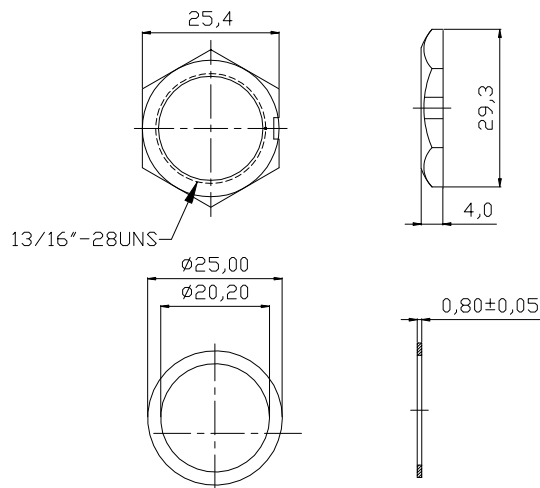

### Order Data/订货信息

Order No/订货号
940000-00-057

### Specifications/技术参数

Materials/材料	PBT + GF
--------------	----------